

PPT VISION Inc.

IMPACT POWER SUPPLIES AND STROBE LIGHTING CABLING FLOW CHART

	<u>Page #</u>
<u>IMPACT:</u> IMPACT POWER SUPPLIES Impact Power Supplies, I/O Cables, Serial Cables, Ethernet cables:	2
IMPACT STROBE CABLES: Impact Strobe cables and Strobe Power supplies:	3 - 4
<u>General Strobe Lighting:</u> STROBE SUPPLIES 661-0114, 661-0183 CABLES	5
SELF-CONTAINED LED STROBE HEAD INTERFACE 661-0308	6
EG&G STROBE INTERFACE 661-0235	7
<u>DSL:</u> DSL HUB STROBE CABLES	8 - 9
<u>Analog (non-DSL):</u> ANALOG DESKTOP & TOWER 661-0151-M, 661-0187-M, 661-0190-M, 661-0119, 661-0119-1, 661-0249	10
ANALOG PASSPORT 661-0117, 661-0118 STROBE CABLES	11

IMPACT POWER SUPPLIES

Impactp.flo

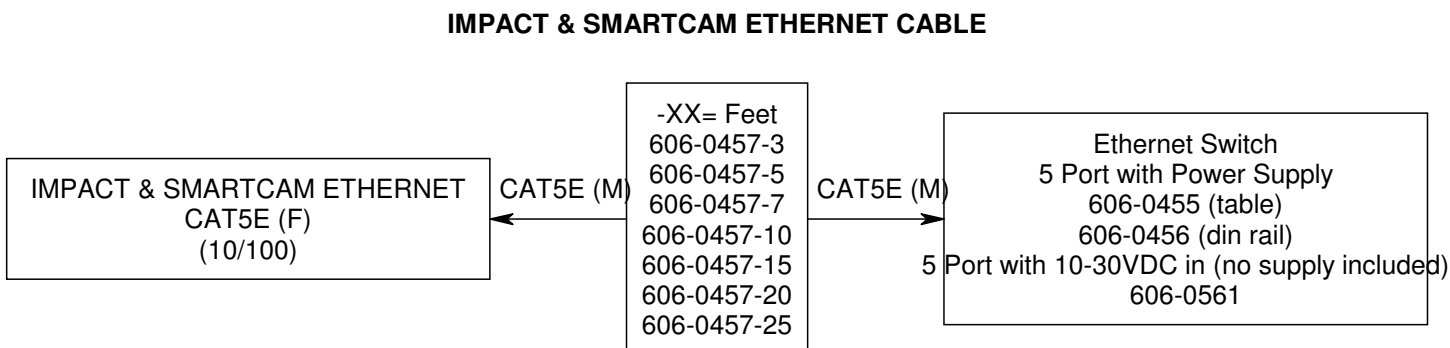
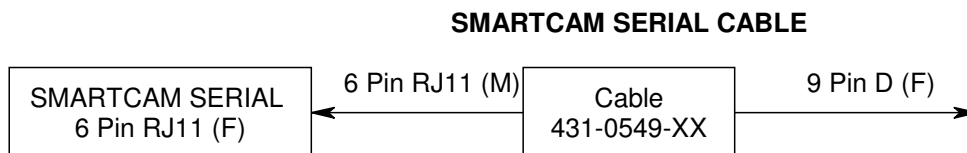
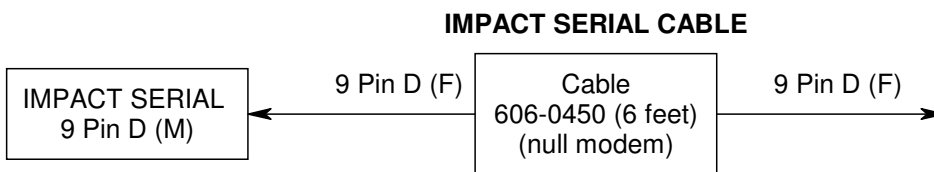
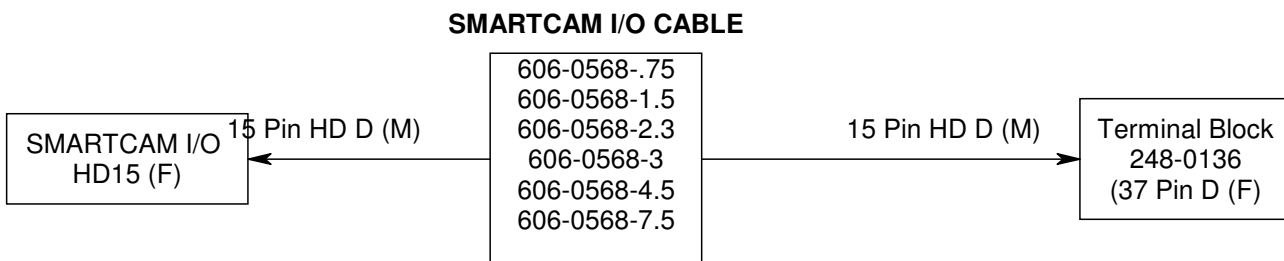
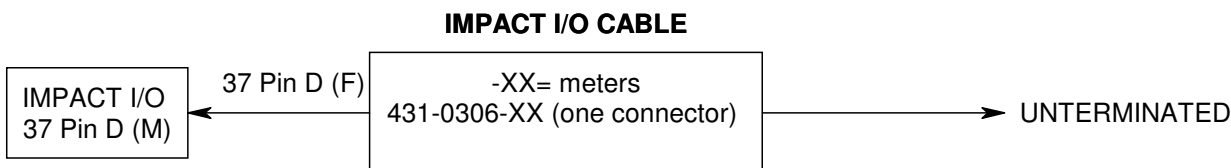
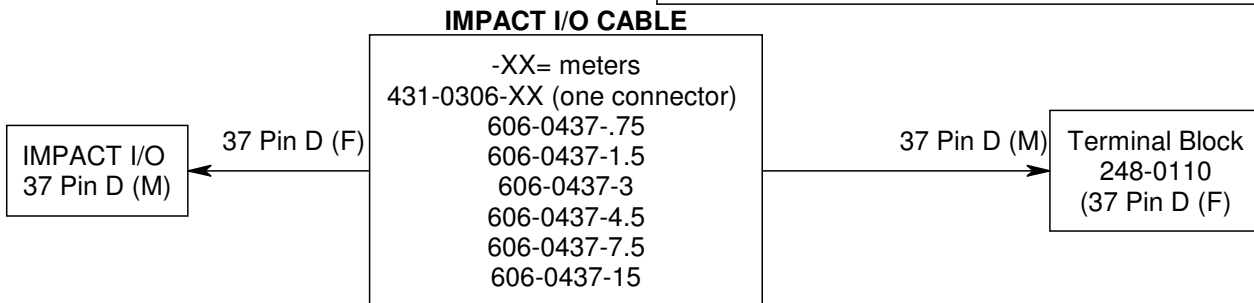
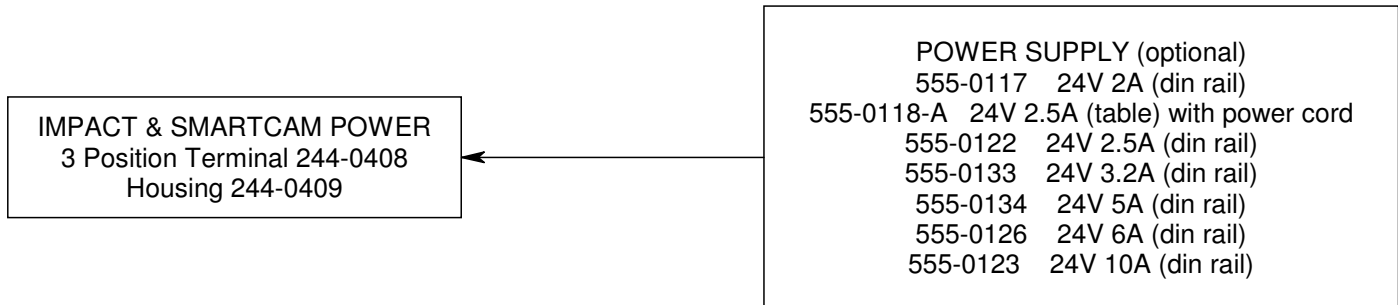

IMPACT STROBE CABLES

Impacts2.flo

Page 1 of 2

IMPACT
15 Pin D
Female

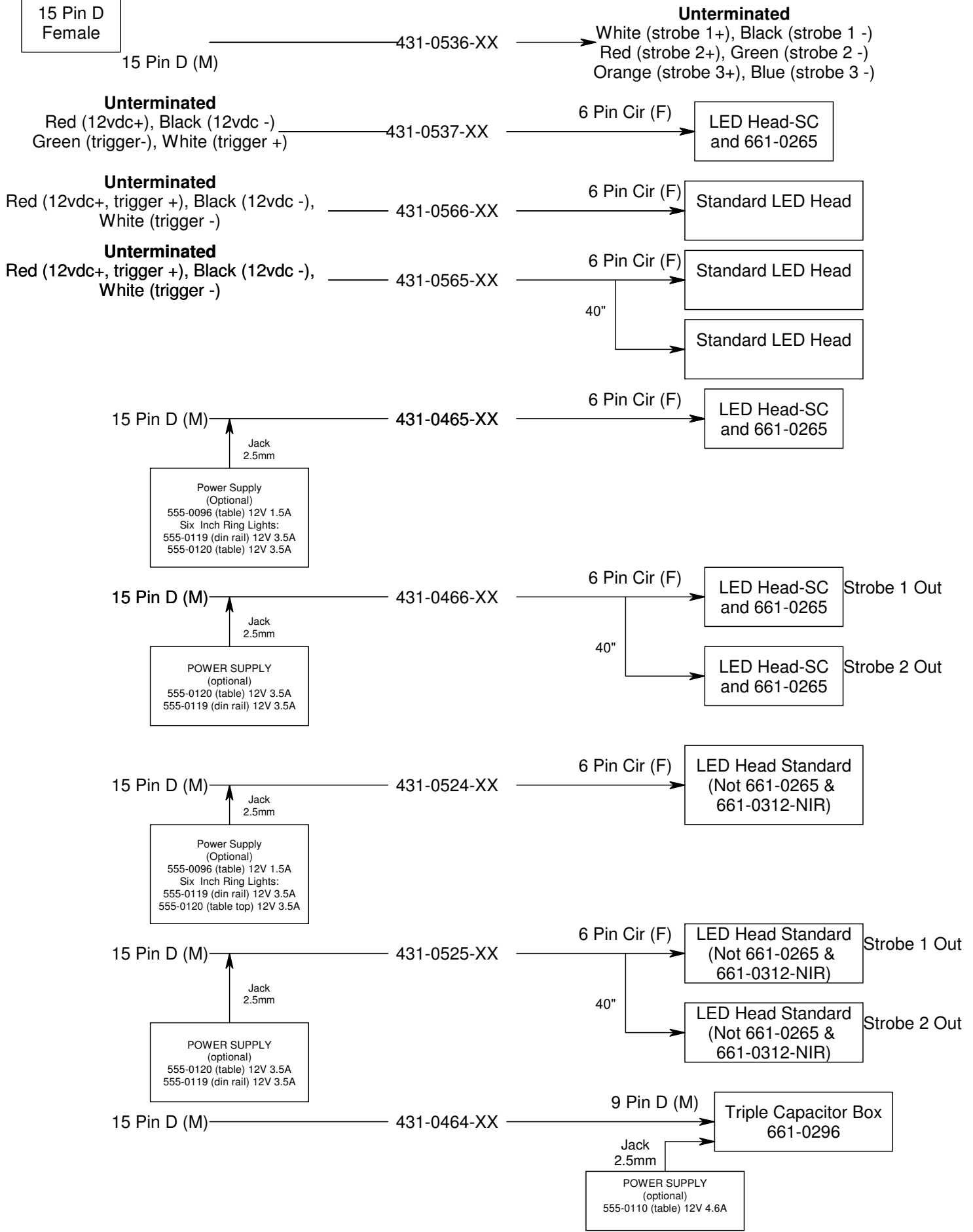

IMPACT STROBE CABLES

Impacts3.flo

Page 2 of 2

IMPACT
15 Pin D
Female

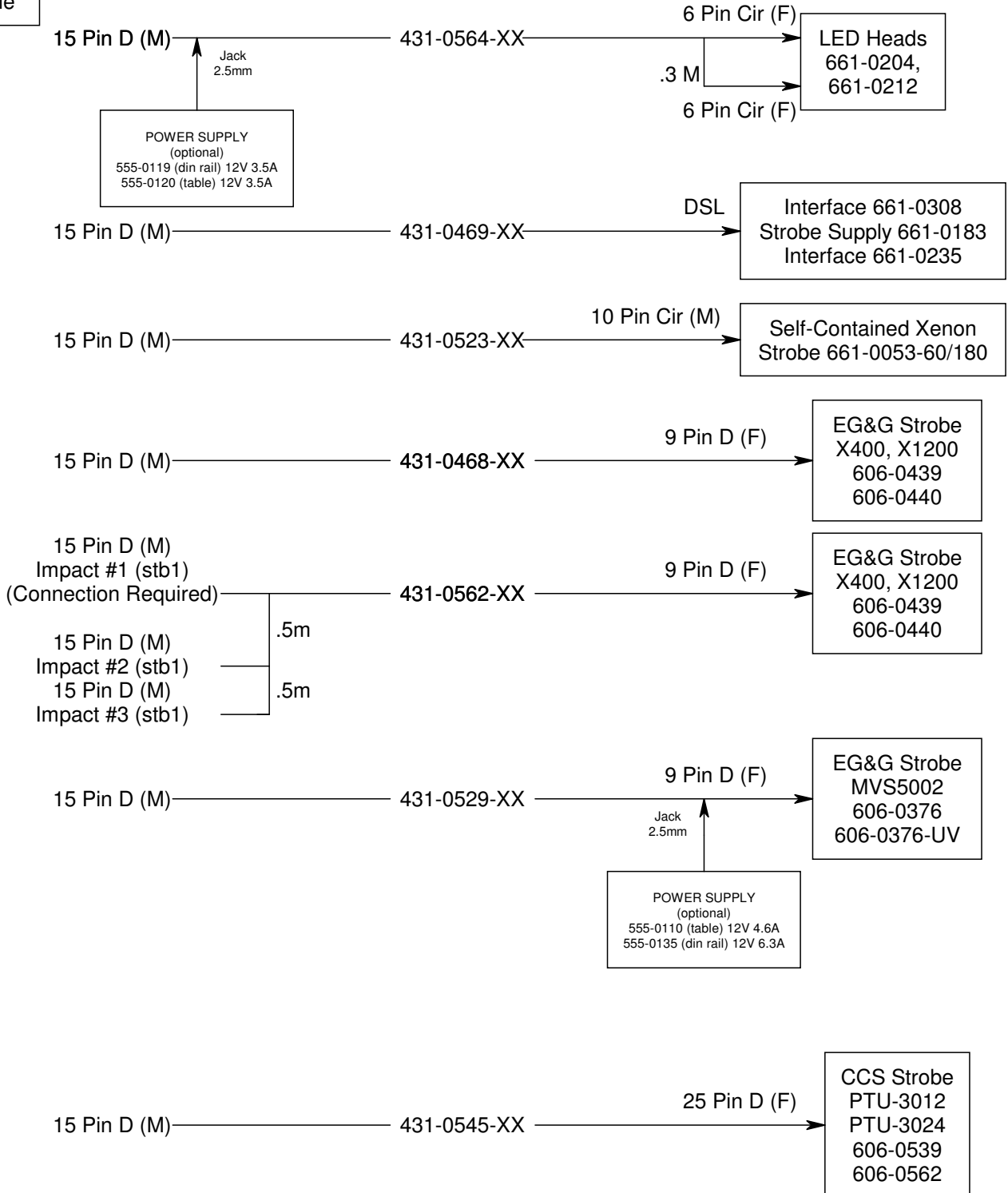

STROBE SUPPLIES 661-0114, 661-0183 CABLES

Strobes.flo

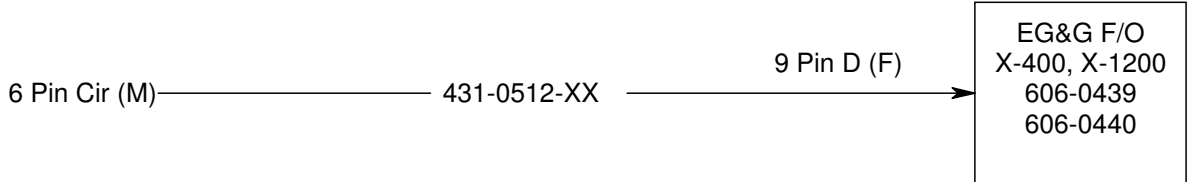
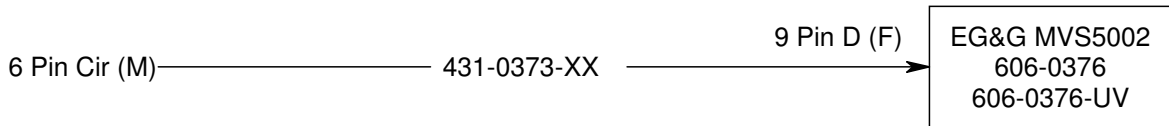
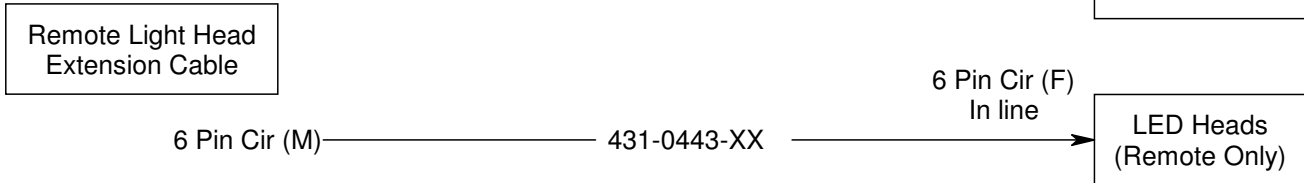
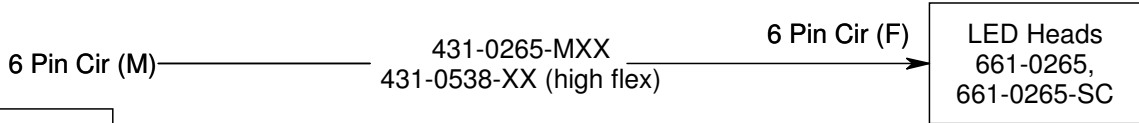
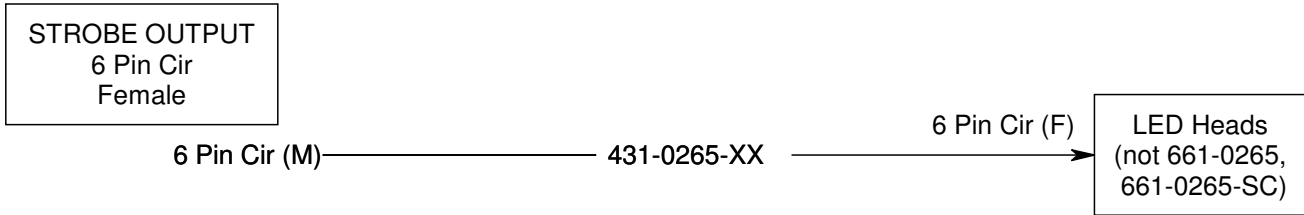

STROBE SUPPLY 661-0114 CABLE

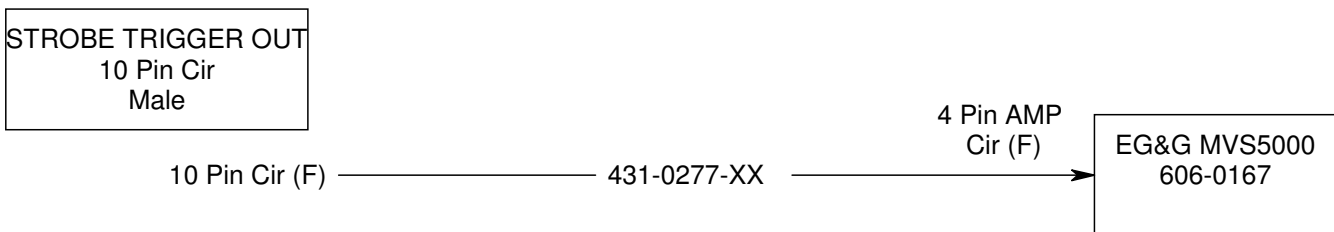

STROBE SUPPLY 661-0183 CABLE

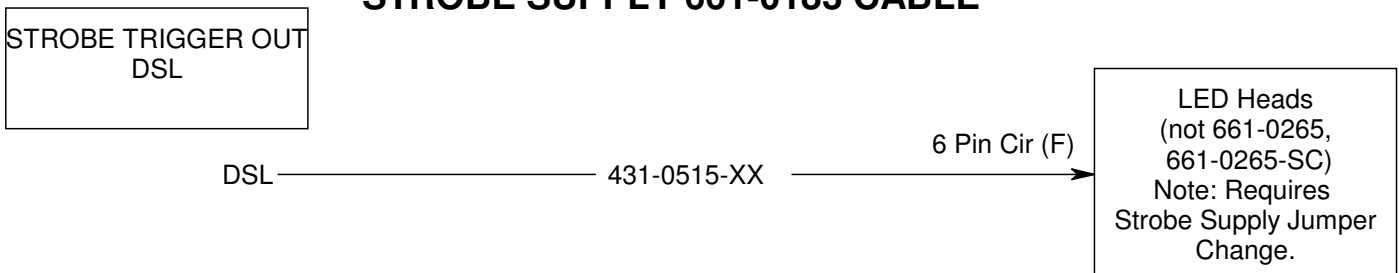

SELF-CONTAINED LED STROBE HEAD INTERFACE 661-0308

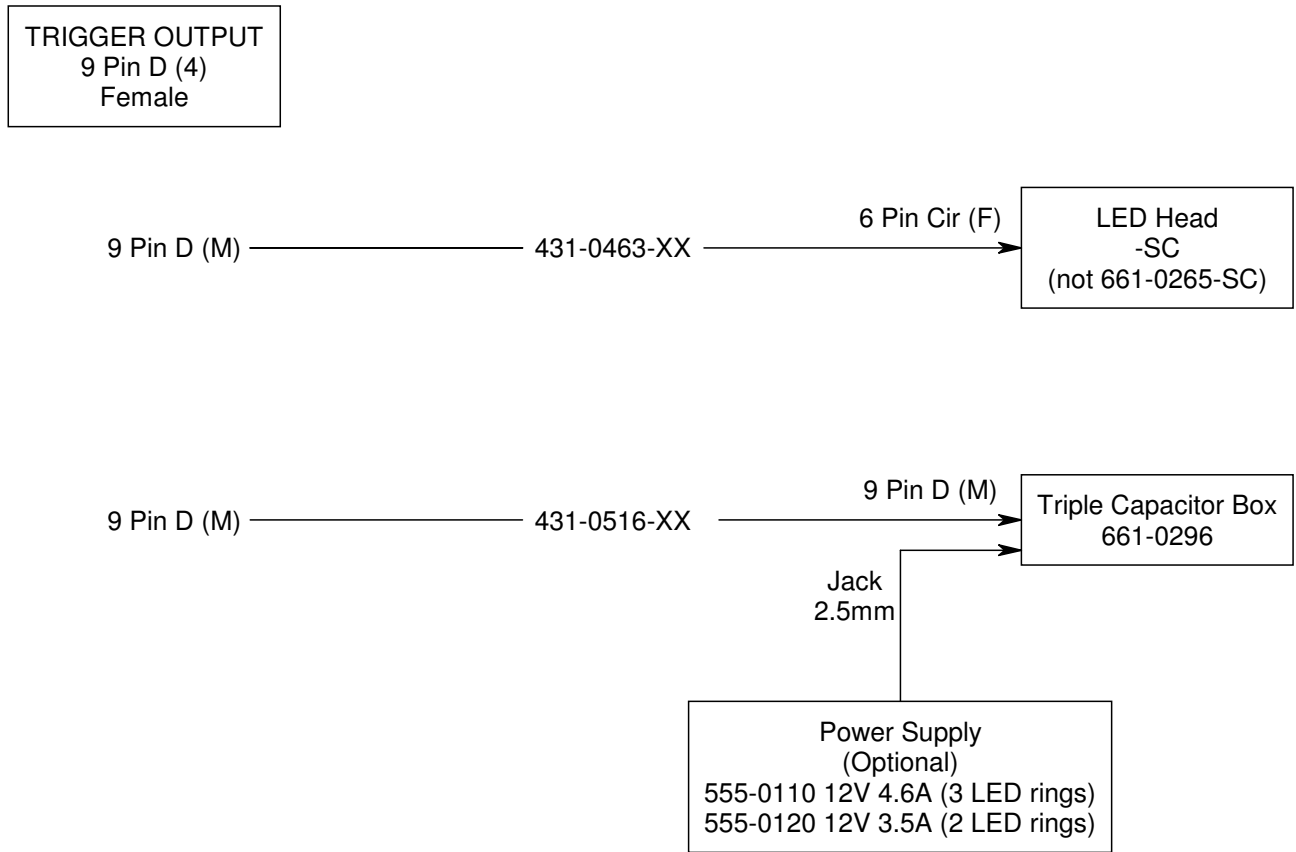

EG&G STROBE INTERFACE 661-0235

Eg&ginte.flo

TRIGGER OUTPUT
9 Pin D (4)
Female

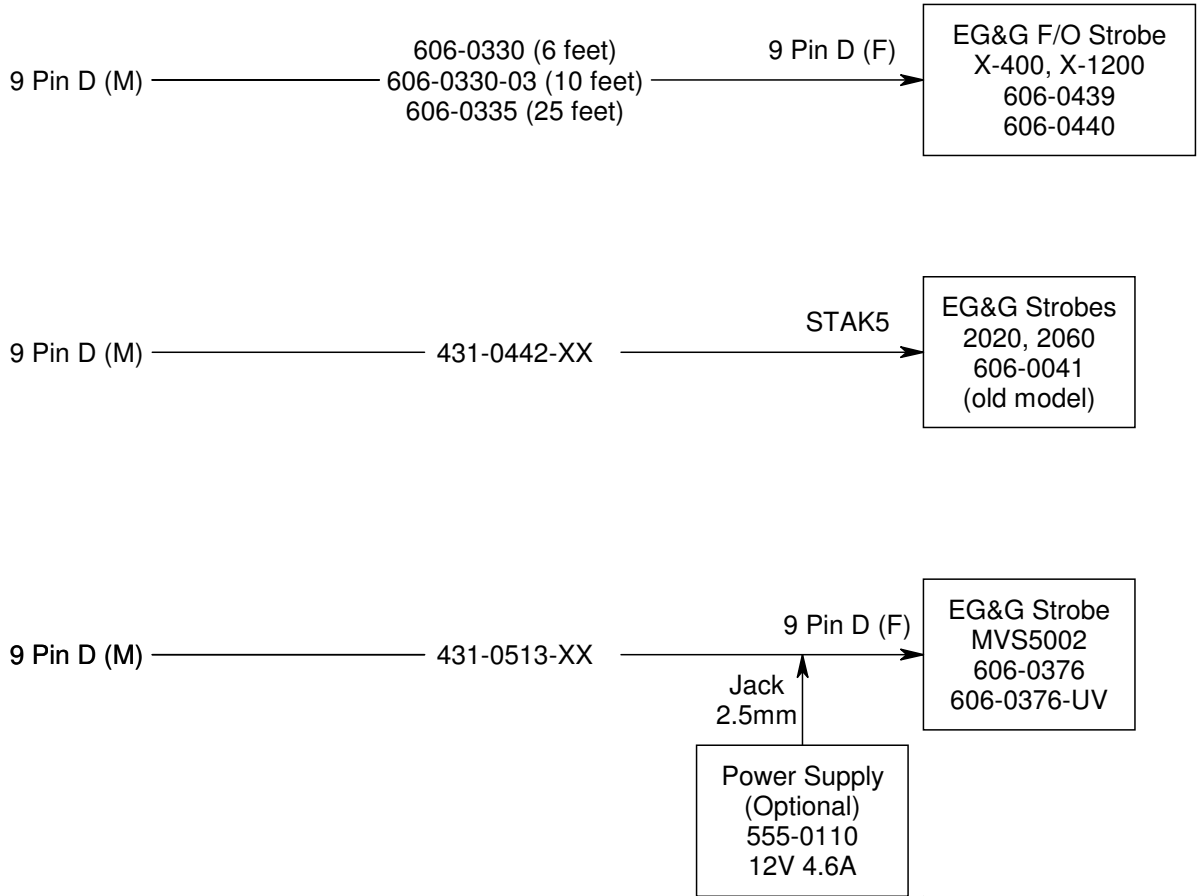

Hub Strobe Out
DSL

DSL HUB STROBE CABLES

hubstro1.flo

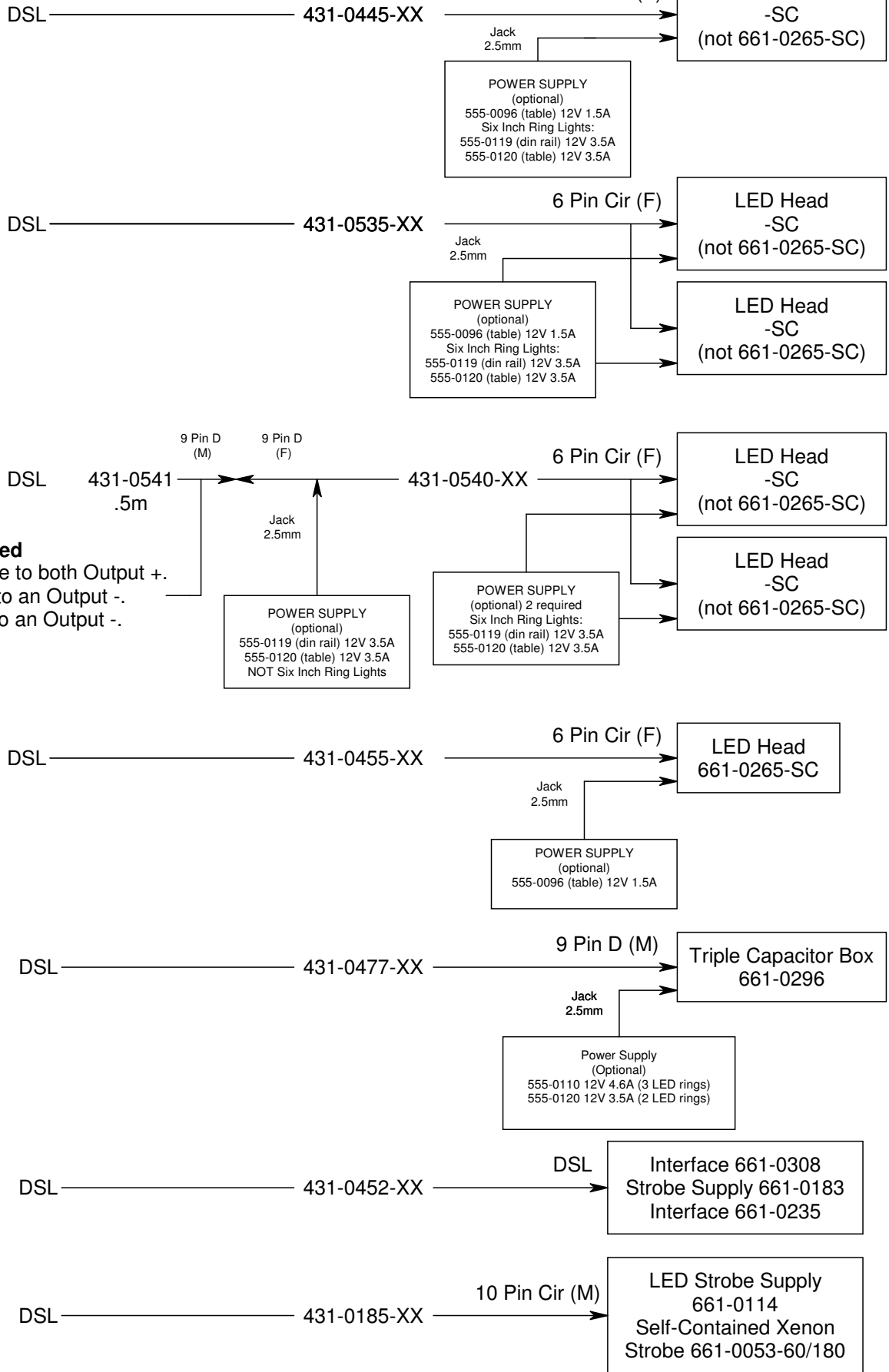

Unterminated

- White & Red (Strobe A-) Wire to both Output +.
- Green (Strobe 1) Wire to an Output -.
- Black (Strobe 2) Wire to an Output -.

DSL HUB STROBE CABLES

hubstro2.flo

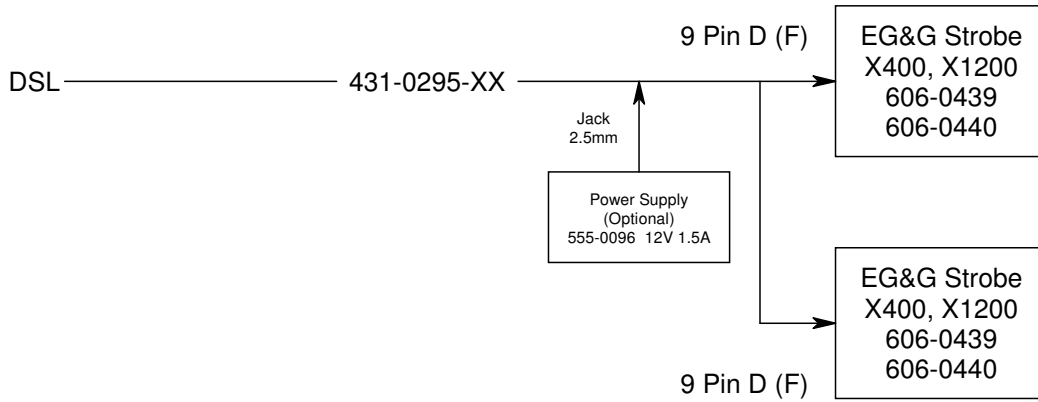
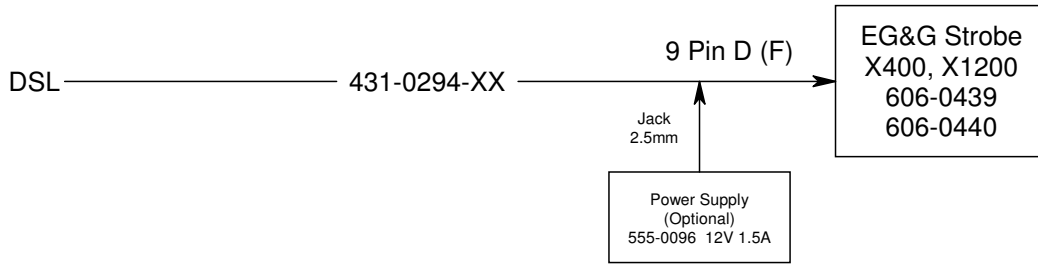

ANALOG DESKTOP & TOWER MODELS

Analogde.flo

661-0151-M, 661-0187-M, 661-0190-M, 661-0119, 661-0119-1, 661-0249 STROBE CABLES

STROBE OUTPUT
9 Pin D
Female

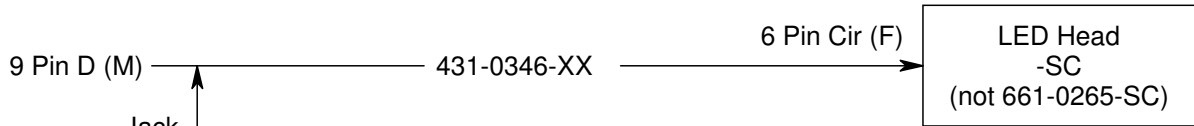
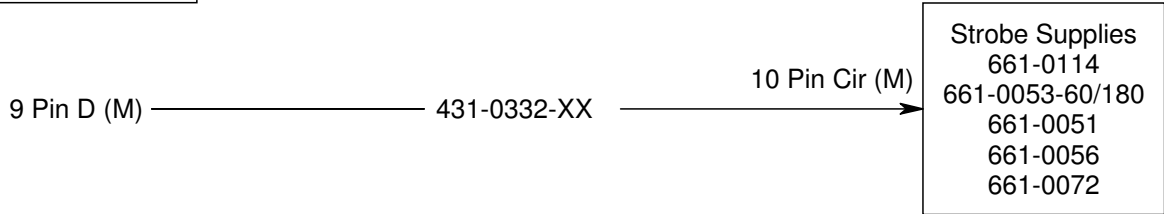

Jack
2.5mm

Power Supply
(Optional)
555-0096 (table) 12V 1.5A
Six Inch Ring Lights:
555-0119 (table) 12V 3.5A
555-0120 (din rail) 12V 3.5A

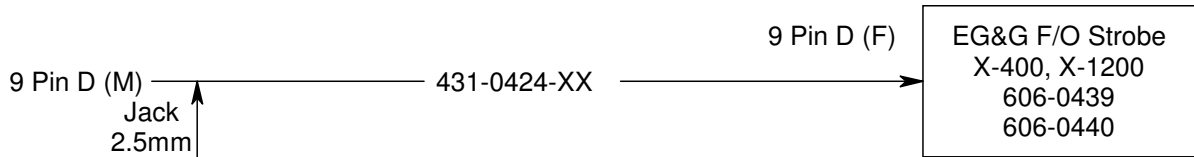

Jack
2.5mm

Power Supply
(Optional)
555-0096 (table)
12V 1.5A

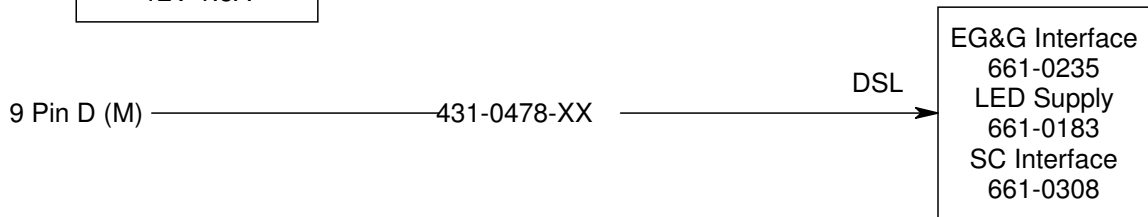

ANALOG PASSPORT 661-0117, 661-0118 STROBE CABLES

Analopa.flo

